

# nobodinoz

D23GGKIDTABLE/025  
D23GGKIDTABLE/026  
D23GGKIDTABLENAT

---

ASSEMBLY INSTRUCTION FOR TABLE  
NOTICE DE MONTAGE POUR TABLE  
INSTRUCCIONES DE MONTAJE PARA MESA

---

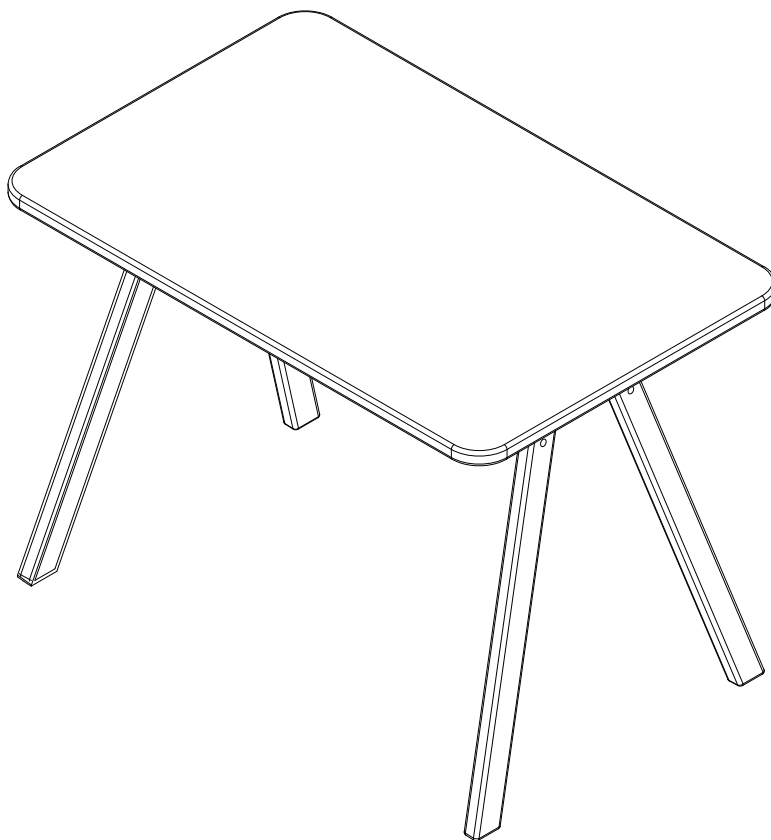

nobodinoz

C/VIC nº10 Bajos  
08006 Barcelona - Spain.  
tel: + 34 93 416 09 49

[www.nobodinoz.com](http://www.nobodinoz.com)

NIF - VAT :  
ES-B64293335

V1 :19032023

# WARNINGS AND ASSEMBLY INSTRUCTIONS FOR THE NOBODINOZ TABLE

EN

## IMPORTANT : READ CAREFULLY AND RETAIN FOR FUTURE REFERENCE

PLEASE MAKE SURE TO FOLLOW THE INSTRUCTIONS PROVIDED BY NOBODINOZ FOR PROPER ASSEMBLY

 **WARNING : FAILURE TO FOLLOW THESE WARNINGS AND THE ASSEMBLY INSTRUCTIONS COULD RESULT IN SERIOUS INJURY OR DEATH.**

 **WARNING: ALWAYS** check security and stability of the table before use.

 **WARNING:** Use the product only when all components are correctly attached and tightened.

 **WARNING : DO NOT** use the table if any part is broken, cracks, torn or missing and use only spare parts approved by the manufacturer. Contact NOBODINOZ for part replacement or to receive new assembly and safety instructions. Make sure the edges are not sharp.

 **WARNING:** All the assembly fittings must always be tightened properly and that fittings should be checked regularly and retightened as necessary.

 **WARNING : DO NOT** place this product near a window as it can be used as a step by the child and cause the child to fall out of the window.

 **WARNING : DO NOT** place this product near a window where cords from blinds or curtains could strangle a child.

 **WARNING : RISK OF FALLING:** prevent your child from climbing on the product.

 **WARNING : BE AWARE OF THE RISK OF OPEN FIRES** and other sources of strong heat in the vicinity of the product.

 **WARNING: DO NOT LEAVE THE CHILD UNATTENDED.**

**IMPORTANT:** The table is made in solid wood. **DO NOT** place the furniture in ambiances with high variation of temperature or humidity, which may cause cracks and pose risks to the child. Always keep the furniture away from direct sun light. It could change the colors.











**IMPORTANT:** Clean with a damp cloth or sponge. **DO NOT** use abrasive cleaner or solvent, which may damage the coating of the paint. For repair, use a non-toxic finish specified for children's products.

**IMPORTANT : THE TABLE IS INTENDED FOR USE OF 3 YEARS AGE OR ABOVE.**



## IMPORTANT : À LIRE ATTENTIVEMENT ET À CONSERVER POUR FUTURE REFERENCE.

**IMPORTANT : À CONSERVER POUR FUTURE REFERENCE & À LIRE ATTENTIVEMENT POUR UN BON MONTAGE, RESPECTER LES INSTRUCTIONS DE MONTAGE FOURNIES PAR NOBODINOZ.**

-  **ATTENTION : NE PAS SUIVRE CES AVERTISSEMENTS OU LES INSTRUCTIONS DE MONTAGE PEUT PROVOQUER DES BLESSURES GRAVES OU LA MORT.**
-  **ATTENTION : TOUJOURS** Vérifiez la sécurité et la stabilité de la table avant utilisation.
-  **ATTENTION :** n'utilisez le produit que lorsque toutes les pièces sont correctement fixées et serrées.
-  **ATTENTION : NE PAS** utiliser la table si une ou plusieurs parties sont endommagées, cassées ou manquantes, et utiliser uniquement des pièces approuvées par le constructeur. Contacter NOBODINOZ pour le remplacement ou pour recevoir une nouvelle notice de montage et de sécurité. Assurez vous que toutes les arêtes soient douces et qu'il n'y ai pas de bords coupants.
-  **ATTENTION :** Toutes les vis d'assemblage doivent être montées et serrées correctement. Elles doivent aussi être contrôlées régulièrement et resserrées si nécessaire. Nettoyer avec un chiffon doux ou avec une éponge humide.
-  **ATTENTION : NE PAS** placer ce produit à proximité d'une fenêtre car il peut servir de marche à l'enfant et entraîner sa chute par la fenêtre.
-  **ATTENTION : NE PAS** placer ce produit à proximité d'une fenêtre où les cordons de stores ou de rideaux pourraient étrangler l'enfant.
-  **ATTENTION : RISQUE DE CHUTE :** empêchez l'enfant d'escalader le produit.
-  **ATTENTION : SOYEZ CONSCIENT DU RISQUE DE FEU ET DES SOURCES DE CHALEUR,** Il existe un risque si on place le produit près du feu ou d'autres sources importantes de chaleur.
-  **ATTENTION: NE PAS LAISSER L'ENFANT SANS SURVEILLANCE.**

**IMPORTANT :** La table est réalisée en bois massif. **NE PAS** placer la table dans un endroit à fortes variations de températures ou d'humidité ce qui peut provoquer des fissures et créer des risques pour l'enfant. **NE PAS** utiliser la table si elle est fissurée ou si le bois présente des fissures. Ne pas exposer la table au soleil direct, cela pourrait altérer la finition et les couleurs.











**IMPORTANT : NE PAS** utiliser de produits au matériaux abrasifs. **NE PAS** utiliser de solvant, cela pourrait endommager la finition. Pour réparation, utiliser uniquement des produits non toxiques spécifiques pour enfants.

**ATTENTION: UNIQUEMENT POUR LES ENFANTS DE PLUS DE 3 ANS.**



## IMPORTANTE: LEA CUIDADOSAMENTE Y CONSERVE PARA FUTURAS REFERENCIAS

PARA UN MONTAJE CORRECTO, ASEGURESE DE SEGUIR LAS INSTRUCCIONES PROPORCIONADAS POR NOBODINOZ

-  **ADVERTENCIA: EXISTE RIESGO DE GRAVES LESIONES O DE MUERTE SI NO SE SIGUEN LAS SIGUIENTES ADVERTENCIAS E INSTRUCCIONES DE MONTAJE.**
-  **ADVERTENCIA: SIEMPRE** verifique la seguridad y estabilidad de la mesa antes de usarla.
-  **ADVERTENCIA:** Utilice el producto solo cuando todos los componentes estén correctamente unidos y colocados.
-  **ADVERTENCIA: NO** utilice la mesa si presenta alguna pieza rota, torcida o ausente y utilizar sólo piezas de repuesto aprobadas por el fabricante. Póngase en contacto con NOBODINOZ para la sustitución de piezas o para recibir nuevas instrucciones de montaje y seguridad. Asegúrese de que los bordes no estén afilados.
-  **ADVERTENCIA:** Todos los tornillos deben estar correctamente montados y apretados. También deben verificarse regularmente y apretarse si es necesario.
-  **ADVERTENCIA: NO** coloque este producto cerca de una ventana, ya que puede ser utilizado como un punto de apoyo por el niño y hacer que el niño se caiga por la ventana.
-  **ADVERTENCIA: NO** coloque este producto cerca de una ventana donde los cables de las persianas o cortinas puedan estrangular al niño.
-  **ADVERTENCIA: RIESGO DE CAÍDA:** evite que su hijo se suba de pie al producto.
-  **ADVERTENCIA: TENGA EN CUENTA EL RIESGO DE FUEGO** y otras fuentes de calor fuerte en las proximidades del producto.
-  **ADVERTENCIA! NO DEJAR NUNCA AL NIÑO DESATENDIDO**

**IMPORTANTE:** La mesa está hecha de madera maciza. NO coloque los muebles en ambientes con alta variación de temperatura o humedad que pueden causar grietas y presentar riesgos para el niño. Siempre mantenga los muebles alejados de la luz solar directa podría cambiar los colores.

**IMPORTANTE:** Limpie con un paño húmedo o esponja. NO utilice limpiador abrasivo ni disolvente. que puede dañar el recubrimiento de la pintura. Para la reparación, use un acabado no tóxico especificado para productos para niños.

**IMPORTANTE: LA MESA ESTÁ DISEÑADA PARA USO DE 3 AÑOS DE EDAD O MÁS.**



ASSEMBLY INSTRUCTION FOR TABLE  
NOTICE DE MONTAGE POUR TABLE  
INSTRUCCIONES DE MONTAJE PARA MESA

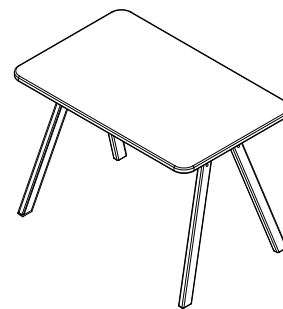

BOX 1/1  
CARTON 1/1  
BULTO 1/1

1x



NAITP01

10x (+2)



NVTP616

4x (+1)

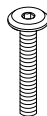

NVTP650

1x



NCLEM401

4x



NVTP1012

2x

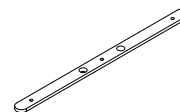

NMP3502

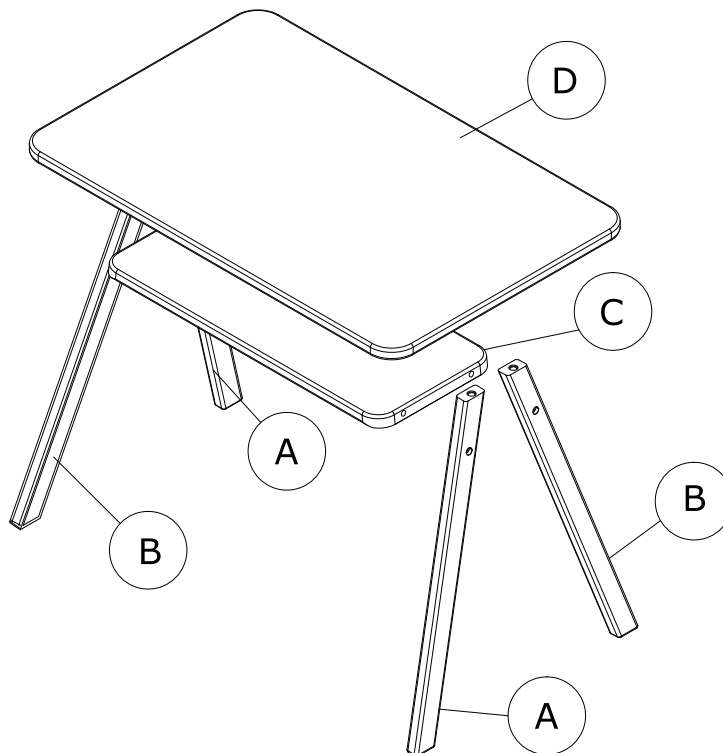

1

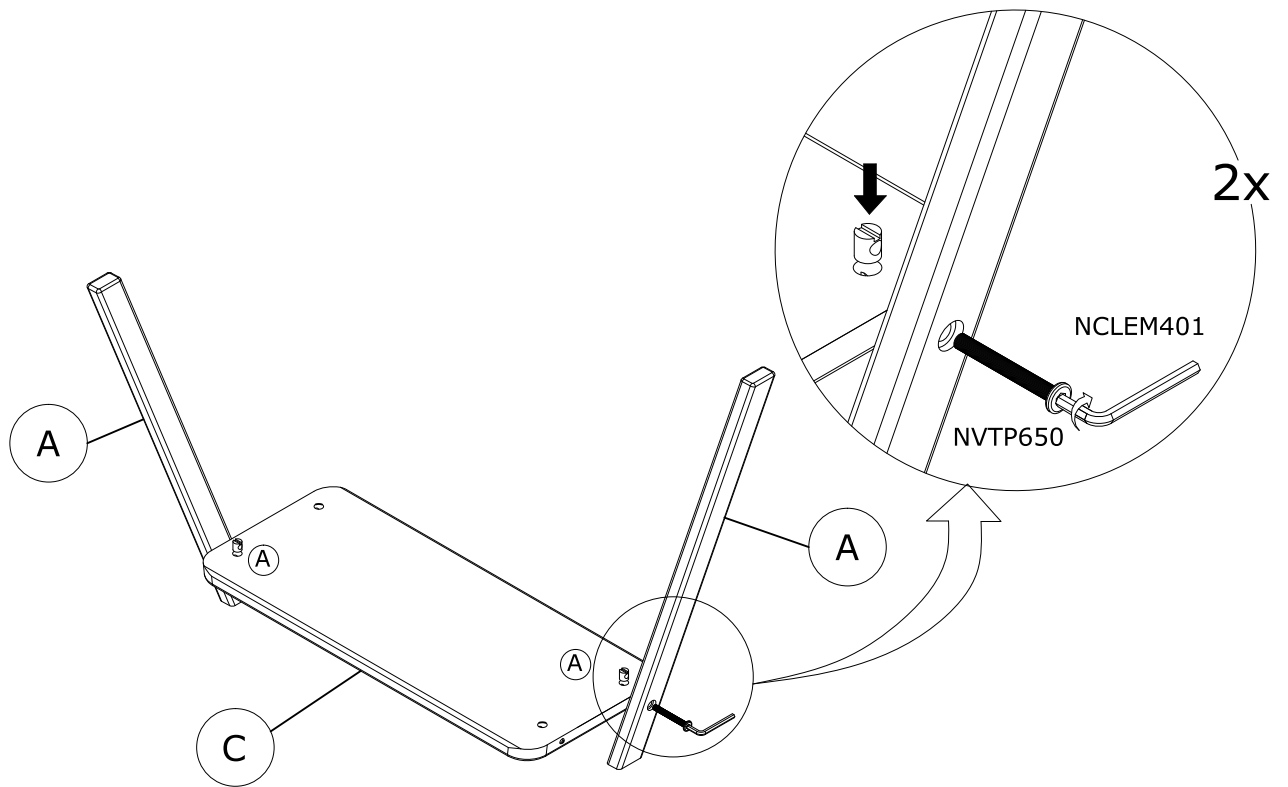

2

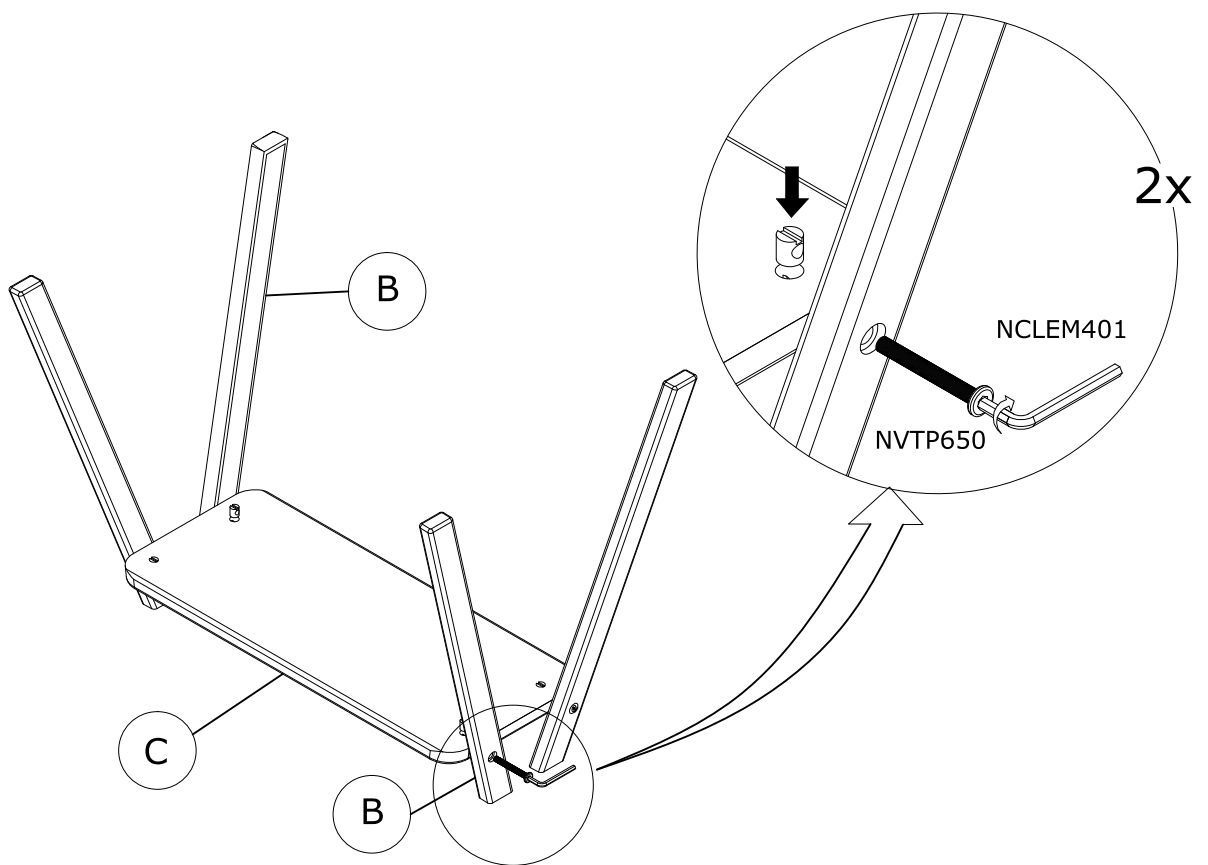

3

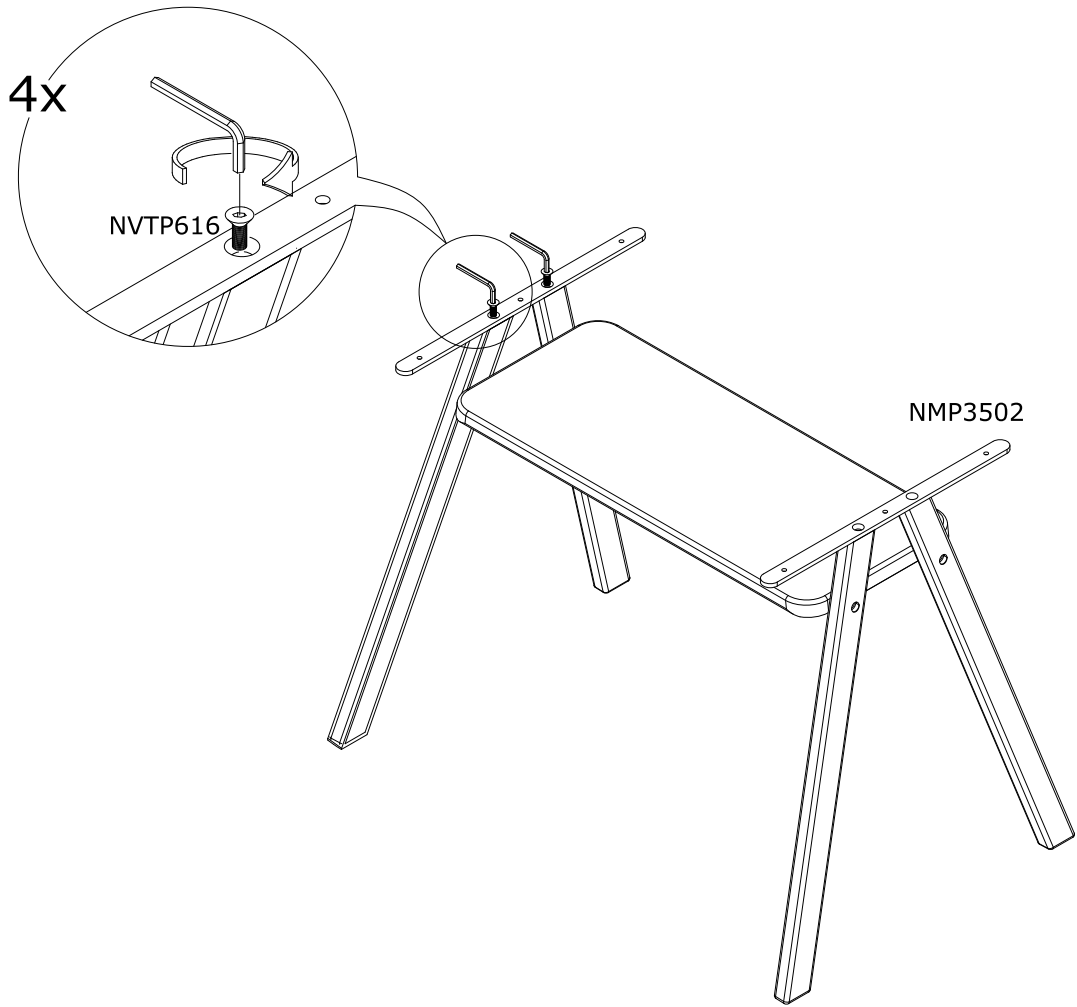

4

